

Wiring Diagram For Remote Receiver With M1 Control Panel

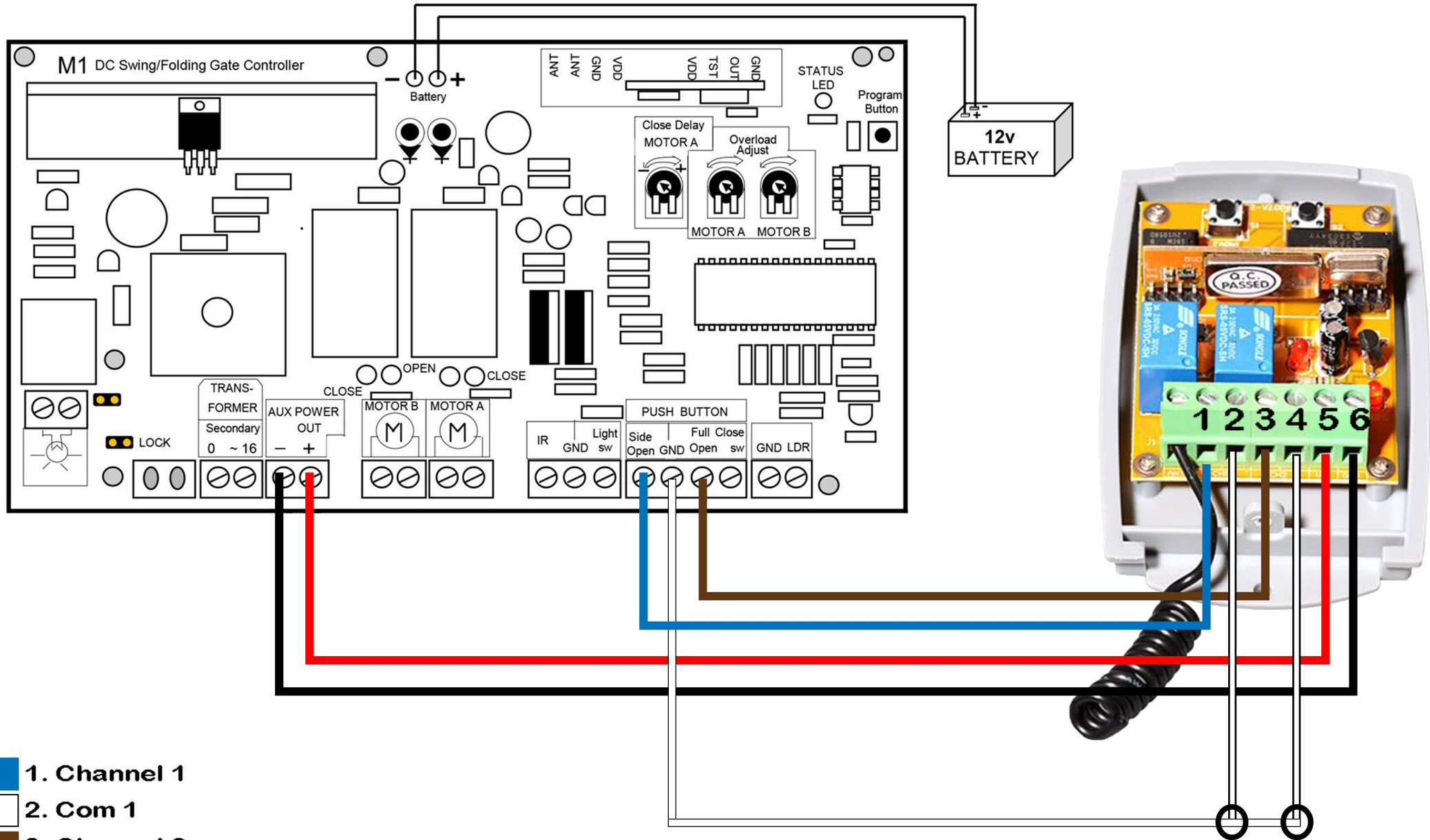

- 1. Channel 1
- 2. Com 1
- 3. Channel 2
- 4. Com 2
- 5. 12v+
- 6. 12v-

Wiring Diagram For Siren With M1 Control Panel

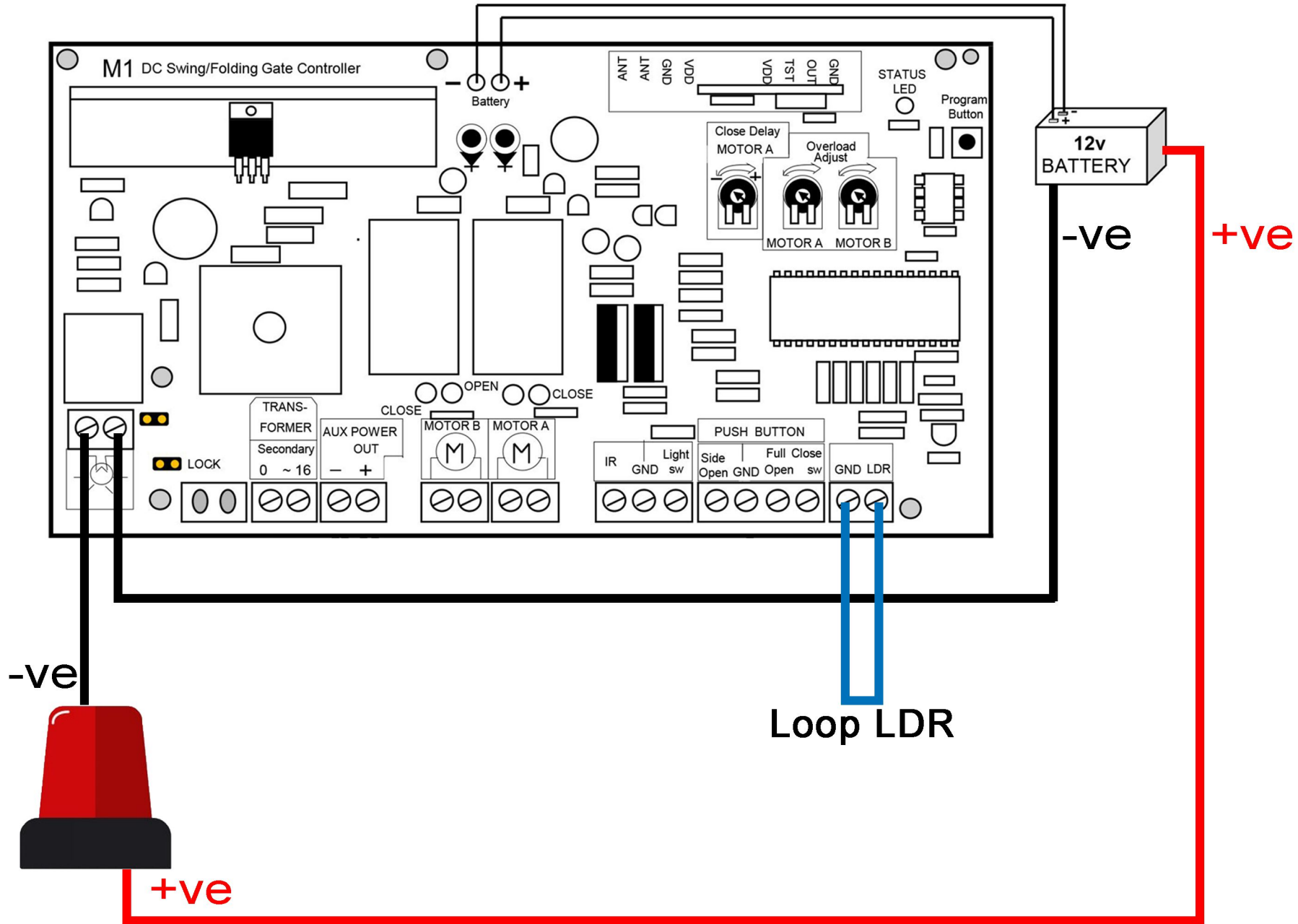

Wiring Diagram For Transformer With M1 Control Panel 9v 9v

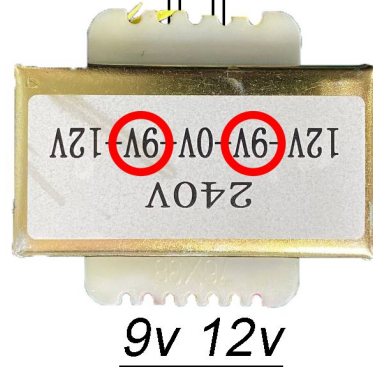
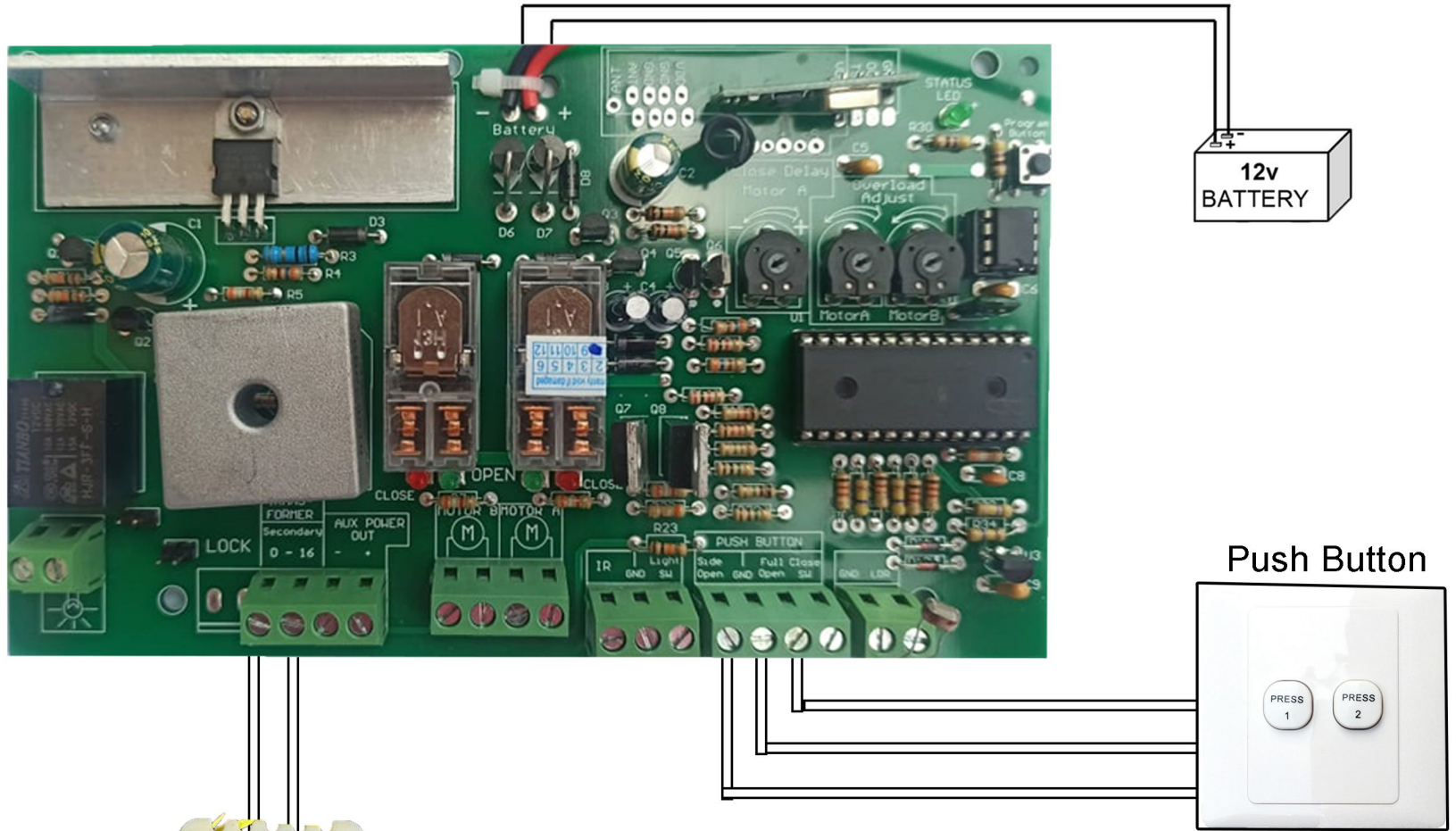
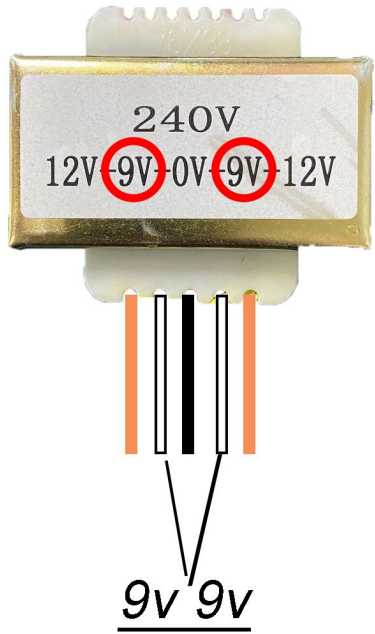

9v 9v - X1 X2 X3 X5 X6
9v 9v - X7

Wiring Diagram For Transformer With M1 Control Panel 9v 12v

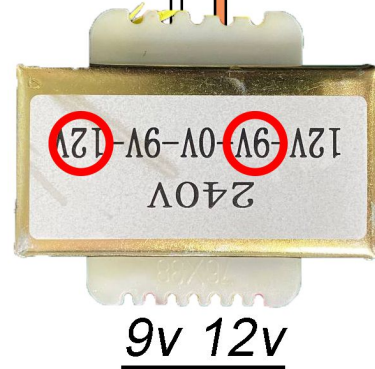
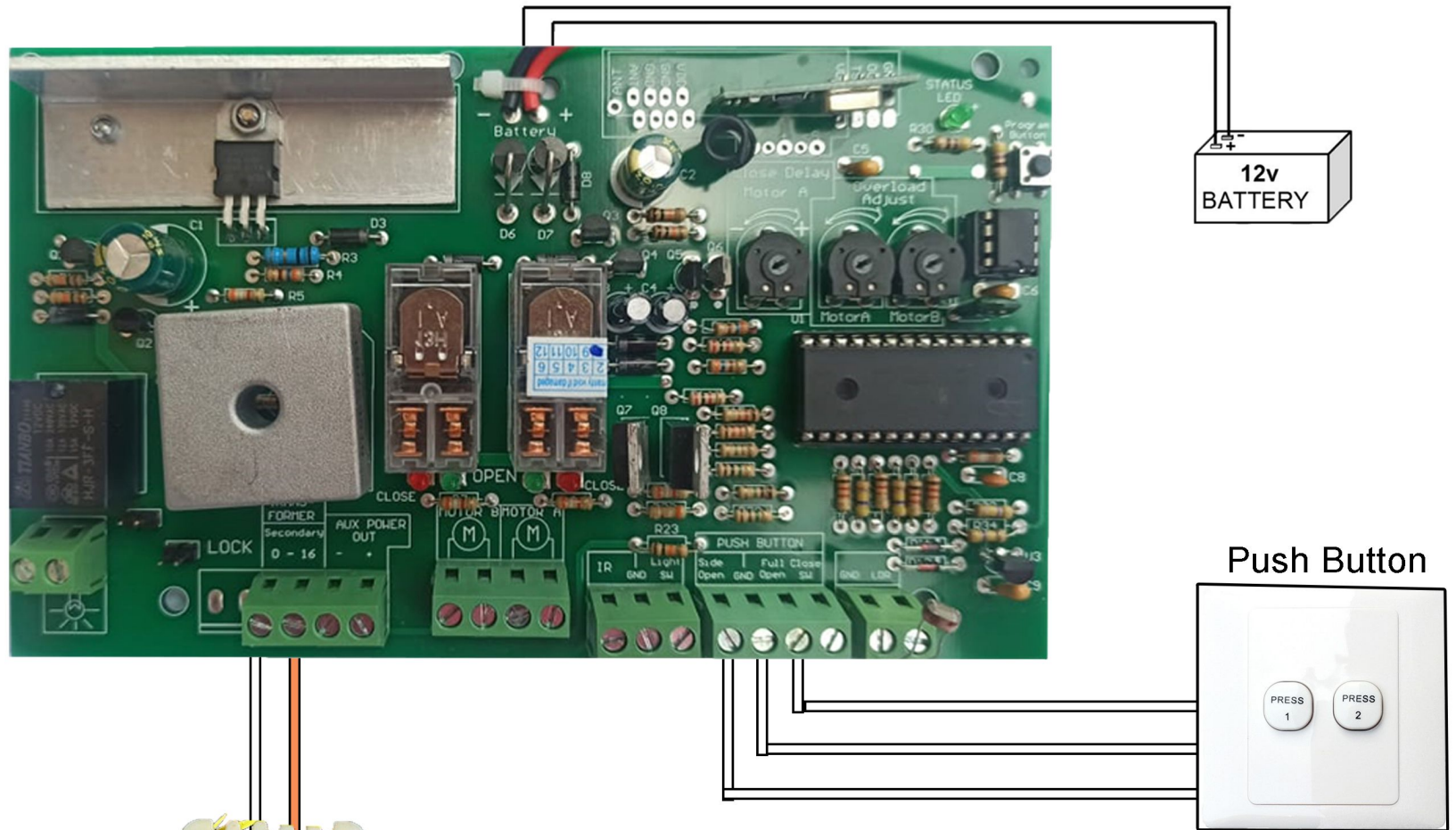
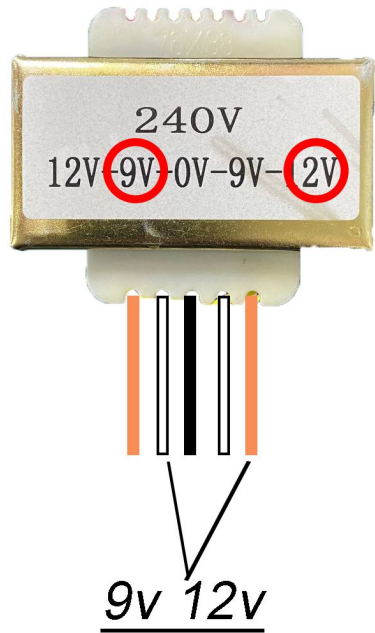

9v 12v - X1 X2 X3 X5 X6

WIRING DIAGRAM FOR FOLDING/SWING MOTOR WITH M1 CONTROL PANEL

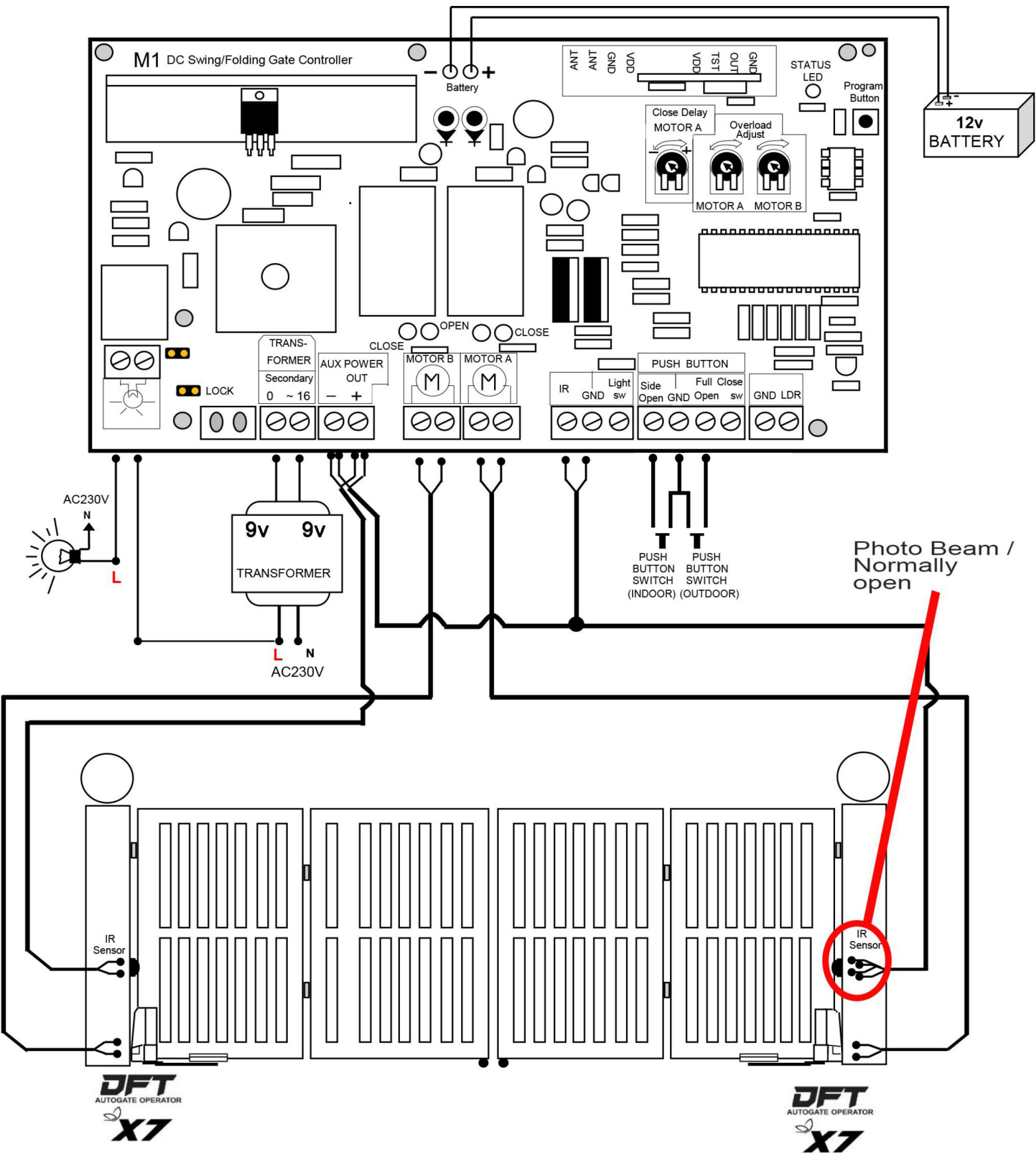

Remote Control Programming Method :

- 1) To Program - Press the " **Program Button** " switch x1 time ,the GREEN LED will ON ,
Then Press the Remote Control (any button), GREEN LED will Blinking
- 2) To Erase - Press and hold the " **Program Button** " switch , 5 -6 second until the LED blinking.

1

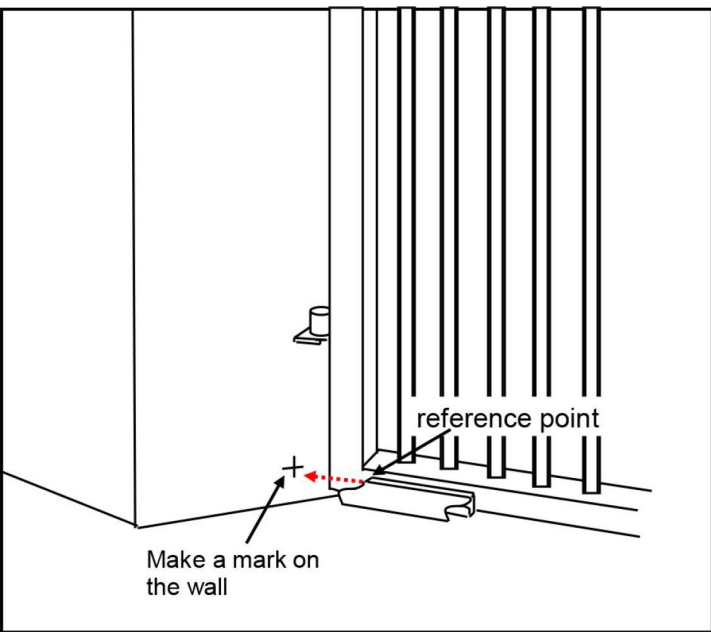

Make a mark on the wall by using the C-channel+base plate

2

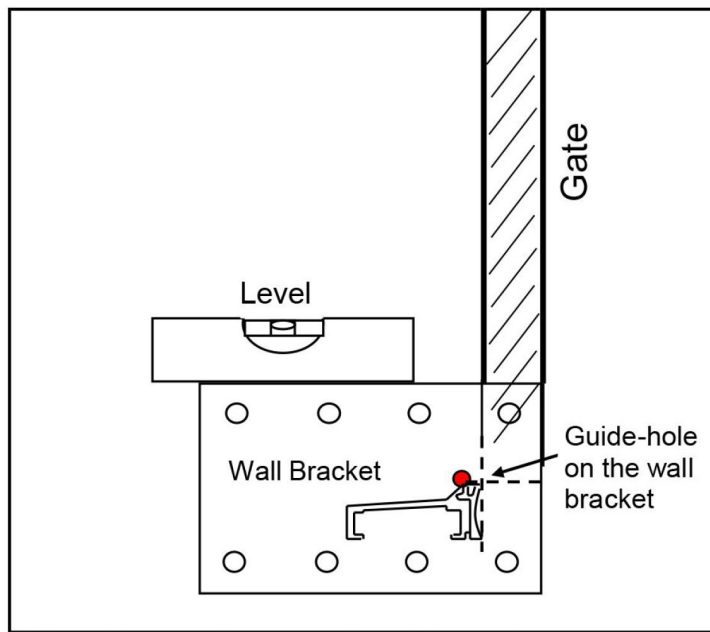

Align the wall bracket guide-hole with the marking point

3

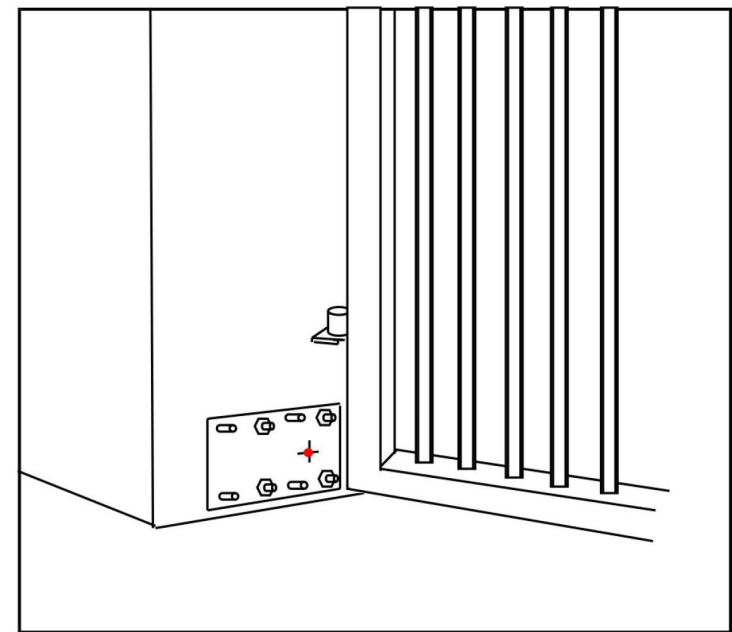

4

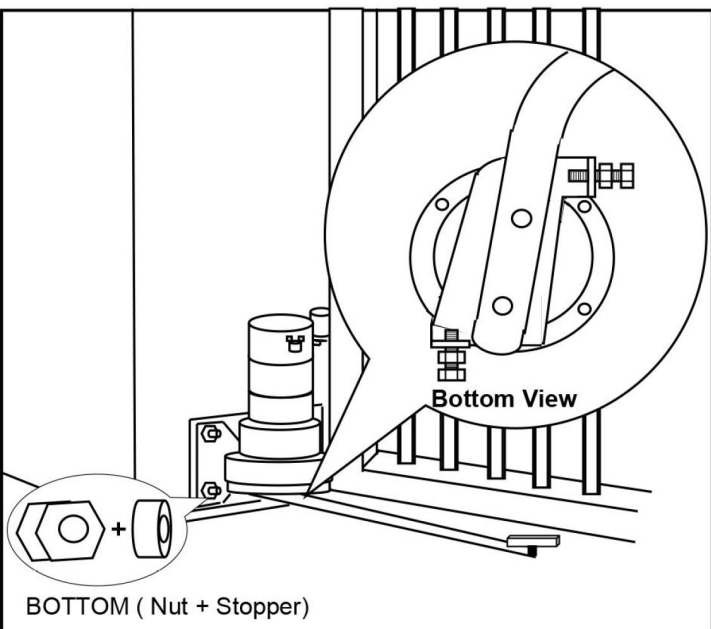

Install the motor & drive bar

5

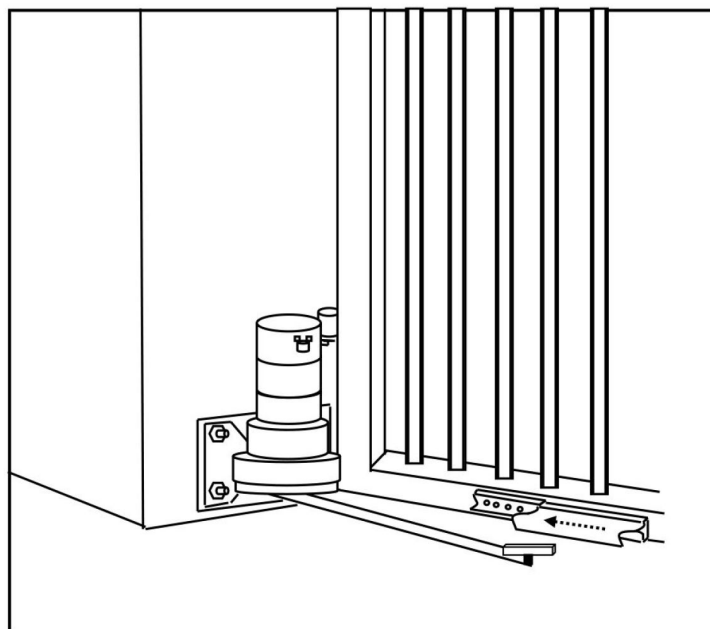

Measure and install the C-channel base plate. Then, Slot in & secure the C-channel

6

